

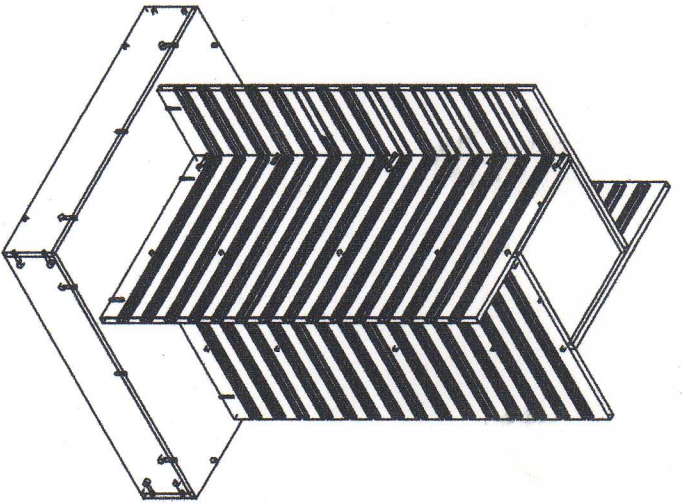







R1530

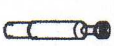

 A:(28)	 B:(28)	 C:∅8*30(16)
 D:∅7*40(8)	 E:(4)	 F:(1)

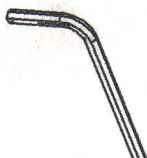
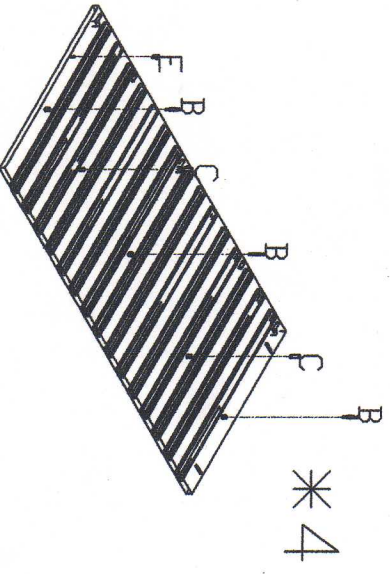
1



 B:(3)	 C:∅8*30(2)	 E:(1)
---	--	---

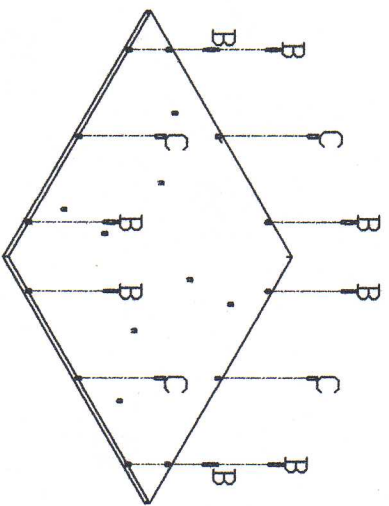

2

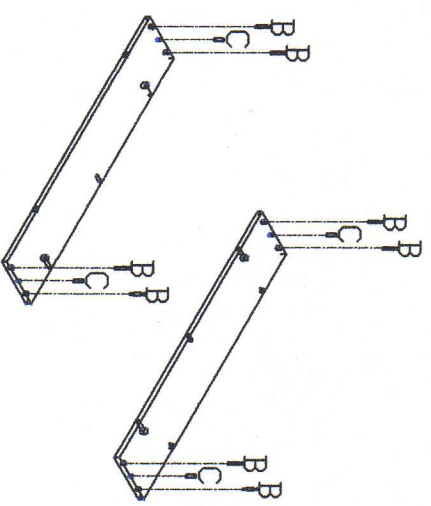

 B:(8)	 C:∅8*30(4)
---	--

3



 B:(8)	 C:∅8*30(4)
---	--

